



RELIABLE ACOUSTIC PROTECTION FOR MICROPHONES

Apertures are essential to sound transmission, but they can also provide an easy point of entry for liquids and particles that can degrade acoustic quality and device reliability.





More effective microphone protection

GORE® Acoustic Vents for Industrial Applications combine the latest technological advancements with more than 30 years of acoustic science expertise to provide venting solutions for varied industrial applications with sound monitoring or voice-control features.

Enhanced sound with advanced ingress protection



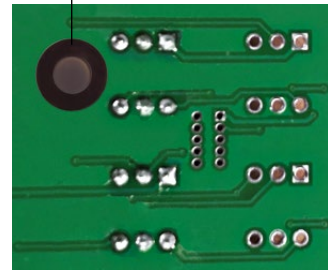
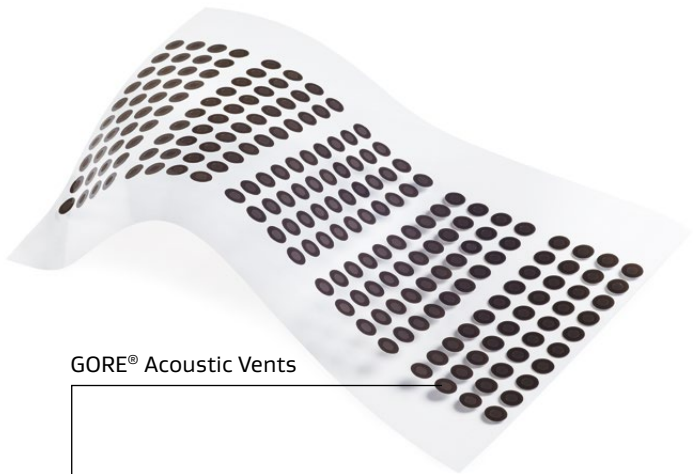

Our newest vents, **Series 400 for Superior Fluids & Dust Protection**, reduce insertion loss to provide enhanced acoustic quality. At the same time, they deliver Gore's highest level of protection against water, other fluids and particles that could degrade device reliability and longevity.

Typical industrial applications:

-  Security cameras
-  Two-way radios (industrial use)
-  Outdoor intercom
-  Human/machine interface devices
-  Smart farming



Our vents enhance acoustic performance while reliably protecting against damaging contaminants.

-  Traffic monitoring
-  Washing machines
-  Interactive information displays
-  Robotic devices
-  Power grid devices

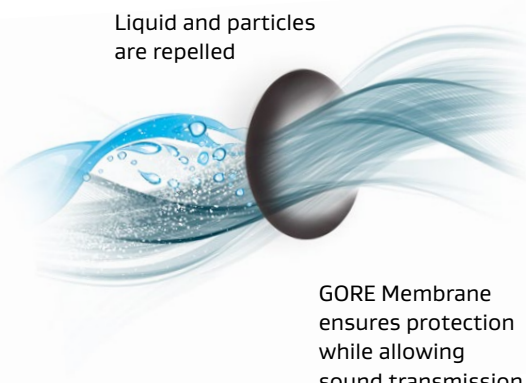

Rising above acoustic challenges

An illustration showing a dark, circular membrane. To its left, blue liquid with white bubbles and small white particles is being repelled, creating a misty spray. To the right, a smooth, flowing stream of blue liquid passes through the membrane. The background is a light blue gradient.

Liquid and particles
are repelled

GORE Membrane
ensures protection
while allowing
sound transmission

Series 400 for Superior Fluids & Dust Protection — Our most advanced ingress protection enables outstanding acoustic performance

Series 400 eliminates the typical trade-offs between reliable waterproofing and superior sound quality. It provides both a high level of ingress protection and superior sound quality, offering a balanced solution for even the harshest environments.

Liquid protection that exceeds typical IP standards

Using Gore protocols, we tested Series 400 against the IPx8 standard. The result: No water leakage while submerged at 2 meters for 30 minutes! Series 400's oleophobic membrane also effectively repels oils, common industrial fluids and cleaning solutions that can threaten devices that use ordinary vent materials. With this level of protection, Series 400 could mean longer-lasting devices.

Particle protection that meets today's needs

Of course, Series 400 has been qualified to meet the IP6x dust-proof performance standard. Additional Gore test protocols that better reflect real-world conditions also show how well this vent performs in assembled devices. For example, Series 400 can protect against a wide range of particles — even those associated with poor air quality, such as smog and dust particulates which may be only 1–10 µm in size.

Series 200 for Splash & Dust Protection — Good environmental protection combined with enhanced broadband acoustic transparency

Series 200 is for industrial devices that face dust and splash hazards yet require very good acoustic performance. Our membrane maintains sound-wave integrity, so it delivers reliable environmental protection without compromising sound quality.

Protects against sprays and particles

Series 200's oleophobic non-woven membrane provides a higher level of spray protection at a given level of acoustic performance. Its three-dimensional tortuous path structure also traps small particles much more efficiently than ordinary woven mesh vents. By providing a more effective barrier to particles of varied sizes and shapes while protecting against acoustic degradation, Series 200 can enhance microphone performance and device reliability.

Characteristics / Performance	Series 234	Series 434
Water protection: IP rating (IEC 60529) ¹	IPx4	IPx4, IPx5, IPx6, IPx7, IPx8 ²
Comparative water spray efficiency ³	75%	100%
Dust protection: IP rating (IEC 60529) ¹	IP5x	IP6x
Insertion loss @ 1kHz ⁴ (ID 2.0 mm)	< 2.0 dB	< 2.0 dB
Membrane type	Cellulose /PET non-woven	ePTFE
Membrane characteristic	Oleophobic	
Reference thickness ⁵	0.33 mm	0.20 mm
Membrane color	Dark gray	Black
Support ring	N/A	PET
Recommended part orientation	Mount on interior of housing	Mount on interior of housing or on PCB
Temperature resistance	-40 °C to 75 °C	-40 °C to 100 °C
Adhesive type installation	Silicone based	
EU-RoHS ⁶	Meets threshold requirements	

- IP ratings for assembled devices depend on the design of the product housing. IPx5, IPx6 feasible with adequate protection grill or cap.
- Test parameters IPx8: 2.0 m water @ 30 min
- Per Gore Water-Spray-VSZ-WI-026: based on IEC60529 - IPx4, test plate: thickness: 2.0 mm; hole: 2.54 mm, average spray efficiency 0% efficiency represents open conditions; 100% represents waterproof
- Tested using a typical MEMS microphone system, membrane ID 2.0 mm. Design of assembled device will affect performance.
- Nominal aggregate thickness of all layers. Actual thickness may vary due to the compressibility of materials.
- To the best of our knowledge, the parts listed above do not have any restricted substances above the maximum concentration values listed in RoHS Directive 2011/65/EU. This information is based on our current level of knowledge and does not constitute a representation or warranty beyond those contained in our standard terms and conditions.

Splash & Dust Protection Series 234

P/N	ID [mm]	OD [mm]
AVP2341.53.5	1.5	3.5
AVP2342.04.0	2.0	4.0
AVP2342.55.0	2.5	5.0
AVP2343.06.0	3.0	6.0

Packaging: Supplied on sheets

Superior Fluids & Dust Protection Series 434

P/N	ID [mm]	OD [mm]
AVP4341.53.5	1.5	3.5
AVP4342.04.0	2.0	4.0
AVP4342.55.0	2.5	5.0
AVP4343.06.0	3.0	6.0
AVP4344.08.0	4.0	8.0
AVP4345.09.4	5.0	9.4

Packaging: Supplied on sheets

P/N	ID [mm]	OD [mm]
AVP4345.09.4-1	5.0	9.4

Packaging: Supplied on rolls

Design and Dimensions

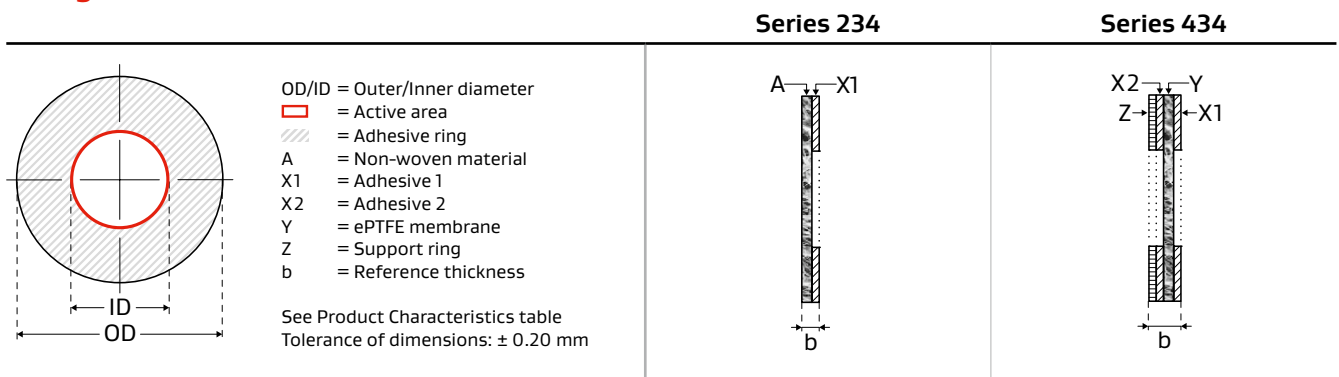

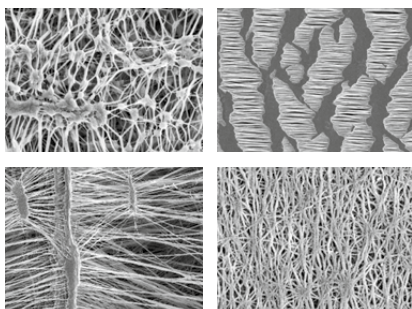

The GORE Membrane: The heart of our venting technology

What gives our vents their superior performance qualities is expanded polytetrafluoroethylene (ePTFE). Gore invented this remarkably versatile polymer, and its capabilities are at the heart of all our products. Our company's expertise is in tailoring the structure and properties of ePTFE to create a wide range of GORE Membranes that are engineered to meet the challenges of diverse — and demanding — applications.

Our knowledge of fluoropolymers and our advanced engineering capabilities are at the heart of a wide range of remarkable materials.

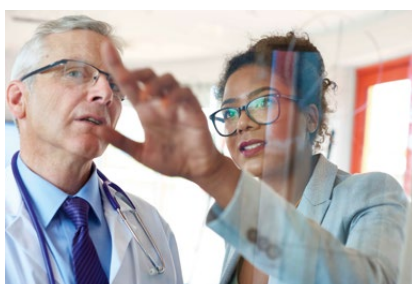

A materials science company dedicated to transforming industries and improving lives

About Gore

W. L. Gore & Associates is a global materials science company dedicated to transforming industries and improving lives. Since 1958, Gore has solved complex technical challenges in demanding environments — from outer space to the world's highest peaks to the inner workings of the human body. With more than 13,000 Associates and a strong, team-oriented culture, Gore generates annual revenues of \$4.8 billion.

Gore develops products and technologies that address complex product and process challenges in a variety of markets and industries, including aerospace, automotive, pharmaceutical, mobile electronics and more. Through close collaboration with industry leaders across the globe, Gore enables customers to design their products and processes to be safer, cleaner, more productive, reliable, durable and efficient across a wide range of demanding environments.

Learn more at gore.com/protectivevents

FOR INDUSTRIAL USE ONLY. Not for use in food, drug, cosmetic or medical device manufacturing, processing, or packaging operations.

GORE® Protective Vent(s) are manufactured under the generic industrial ISO 9001 quality system. No other certifications can be provided by Gore for this GORE® Protective Vent. All technical information given is based on Gore's previous experiences and/or test results. Gore gives this information to the best of its knowledge, but assumes no legal responsibility. Customers are asked to check the suitability and usability in the specific application, since the performance of the product can only be judged when all necessary operating data are available. The above information is subject to change and is not to be used for specification purposes. Gore's terms and conditions of sale apply to the sale of the products by Gore.

GORE, *Together, improving life* and designs are trademarks of W. L. Gore & Associates. © 2021–2024 W. L. Gore & Associates GmbH

INTERNATIONAL CONTACTS

Australia +61 2 9473 6800
Benelux +49 89 4612 2211
China +86 21 5172 8299
France +33 1 5695 6565
Germany +49 89 4612 2211
India +91 22 6768 7000

Italy +39 045 6209 240
Japan +81 3 6746 2570
Korea +82 2 393 3411
Mexico +52 81 8288 1281
Scandinavia +46 31 706 7800
Singapore +65 6733 2882

South America +55 11 5502 7800
Spain +34 93 480 6900
Taiwan +886 2 2173 7799
United Kingdom +44 1506 460123
USA +1 410 506 7812

W. L. Gore & Associates GmbH
Hermann-Oberth-Str. 26, 85640 Putzbrunn, Germany
T +49 89 4612 2211 **F** +49 89 4612 2302 **E** protectivevents@wlgore.com
gore.com/protectivevents

